

Content

1. Introduction.....	1
2. Precautions.....	1
3.Product Introduction	
3-1 Specifications & Features.....	1
3-2 Front Panel.....	2
3-2-1 Display.....	2
3-2-2 Keyboard.....	3
3-3 Rear Panel.....	4
3-4 Power supply.....	4
4. Installation	
4-1 Load cell connection.....	4
4-2 Assembly Description of Upright Pole.....	5
5. Setting Mode	
5-1 Maximum Weighing Capacity & Division Setting.....	6
5-2 Function Setting.....	7
5-3 Description of Parameter Values.....	7
6. Calibration.....	10
7.Operation	
7-1 Weighing.....	11
7-2 Tare.....	11
7-3 Check Weighing.....	12
7-4 Simple Counting.....	13
7-5 Input Demand.....	14
8. Error message and Trouble Shootings.....	14

1. Introduction

Thank you for deciding to purchase a JWI-3000 Weighing indicator. This goods has the excellent performance and splendid properties under severe quality management .It is recommended to read this manual in full before using it for good function application.

2. Precautions

- ⊙ Place the indicator on a flat and stable surface.
- ⊙ Verify that the input voltage and the plug type matches the local AC power supply. See 3-4 power supply.
- ⊙ Warm up for 15 minutes before using first time.
- ⊙ Keep the indicator away from EMI noise, strong wind and vibration, which might cause incorrect reading.
- ⊙ Avoid sudden temperature changes (suitable operating temperature is between 0℃~ 40℃.)
- ⊙ Disconnect the power supply when cleaning the indicator
- ⊙ Do not immerse the indicator in water or other liquids

3. Product Introduction

3-1 Specification and Feature

Specification

Model	JWI-3000
Input sensitivity	0.2uV/DIV
Input voltage range	-2mV to 20mV
Load cell excitation	DC 5V ,Up to 4 x350 ohm load cells
System linearity	0.007% of full capacity
Input impedance	10M ohm or more
A/D conversion mode	Δ - Σ
A/D internal resolution	700,000 count
A/D conversion speed	10 times/second
External display resolution	15,000 count
Display	6 digits
Power supply	AC 100V/220V (AC \pm 10%) or Rechargeable battery (6V/4A)

Feature

- Up to 1/15000 resolution
- Attractive outline design with durable ABS housing
- Backlit LCD display with prominent 34mm high digits
- Adjustable filtering level for weighing under various conditions
- Zero / Tare / Weighing / Simple counting / Hold / Net & Gross Weight / Check weighing function
- Suitable for a wide range of bases and load cells
- Adjustable capacities, resolutions and parameters (suitable resolution range 300---30000)
- Adjustable stand for bench scale
- Auto shut off / Auto backlight
- Low battery indication with unique charging lamp.

3-2 Front Panel

3-2-1 LCD Display

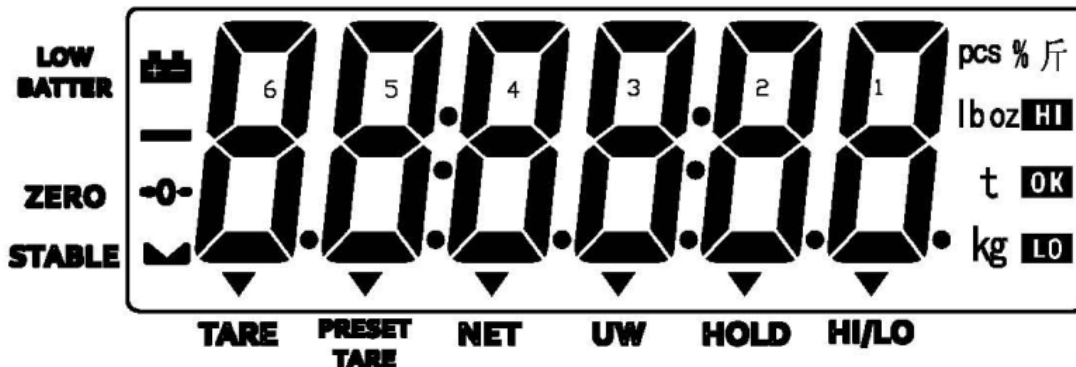

Low battery indication



Center of Zero Indication. The zeroing range is $\pm 2\%$ of scale capacity.



Stable indication

TARE Symbol “▼” points at “**TARE**” when the weight of the container is tared .

Preset Tare Symbol “▼” points at “**Preset Tare**” when Tare value entered via keypad.

NET Net weight--Gross weight minus Tare. Symbol “▼” points at “**NET**” when Tare or Preset Tare action are done.

UW Symbol “▼” points at “**UW**” when calculated unit weight is lower than 4/5 of scale division. Unit weight is too small for ensuring accurate quantity calculations.

HOLD Symbol “▼” points at “**HOLD**” when the hold function is enabled.

pcs % 斤

lb oz

t Units of measure

kg

HI The item on the weighing pan is greater than the upper limit

OK The item on the weighing pan is between upper and lower limits.

LO The item on the weighing pan is smaller than lower limit.

Note : the item on the weighing pan should be more than or equal to 20e.

3-2-2 Keyboard



◀/G/N key

- ☆ Displays gross and net weight by turns
- ☆ Long press for the choice of sampling
- ☆ Shift key(shift leftwards)

+ /PRINT/HI key

- ☆ The number increases one when value setting
- ☆ Print out when setting manual print
- ☆ Long press higher limit initials higher limit setting

-/HOLD/LO key

- ☆ The number decreases one when value setting
- ☆ Remain the weighing display in the window (5 options)
- ☆ Long press lower limit initials lower limit setting

TARE key

- ☆ Tare manually
- ☆ Long press to enter preset tare
- ☆ Shift key (shift rightwards).

ZERO/ESC key

- ☆ Zeros the display
- ☆ Short press to save and exit from the setting mode
- ☆ Long press to exit from the setting mode without saving.

UNIT/SET key

- ☆ Exchange the weighing units
- ☆ Long press to enter the parameter setting

3-3 Rear Panel

1. Port for connecting load cell
2. USB Port
3. RS-232 Port
4. Power socket
5. Power ON/OFF switch

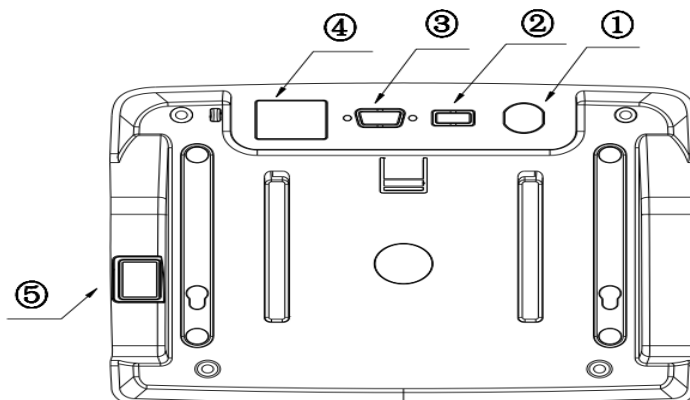

3-4 Power supply

1. Switching power supply (100V~240V)
2. (6V/4A) Internal Rechargeable Battery

Power Consumption

190mW without backlight (about 140 hours available)

288mW with backlight (about 83 hours available)

Low battery warning

When “” appears in the upper left corner of the weight window, the battery power requires recharging. The charge lamp turns green from red when the recharging is completed (which takes about 8 hours). Disconnect the scale from power supply when it is fully charged.

4. Installation Instructions

4-1 Load cell connecting

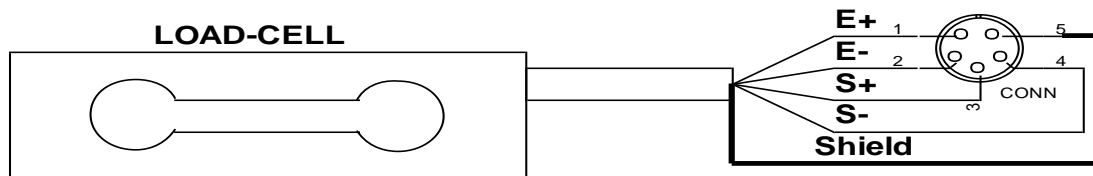

	<i>PIN</i>	<i>SIGNAL</i>
LOAD CELL CONNECTION	1	E+
	2	E-
	3	S+
	4	S-
	5	SHIELD

4-2 Assembly Description of Upright Pole

1. Rod seat
2. Upright pole
3. Bracket
4. Indicator
5. Screw (for fixing the upright pole)
6. Screw (for fixing the bracket)
7. Knob pole
8. Bracket slot
9. Load cell wire

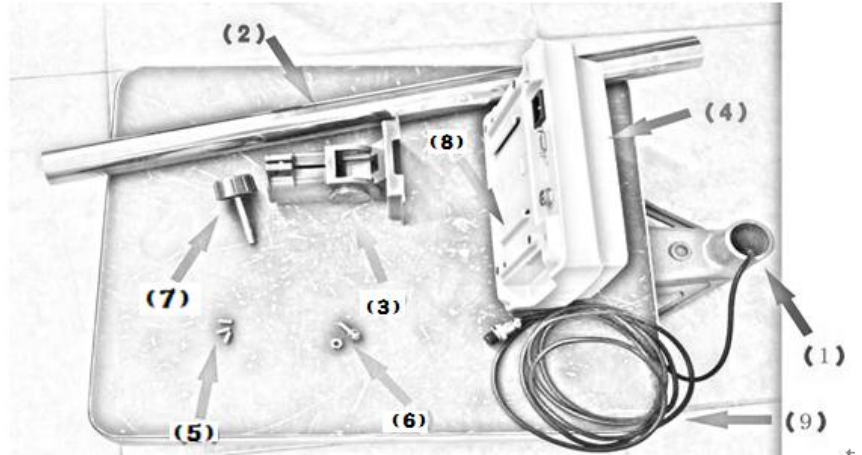

Step 1: Thread the wire of the Load Cell (9) on the Rod seat (1) through the upright pole (2), insert the upright pole into the rod seat and then lock it with two screws (5).



Step 2: After threading the Load Cell wire through the bracket (3), attach the bracket to the upright pole and then lock it with the screw (6).



Note: if the load cell connector is too big to thread through the bracket, separate the bracket by removing the knob pole (7), see the following pictures.



Step 3: Install the Indicator (4) on the bracket, with the bracket aligning with the bracket slot (8) of the indicator.



Step 4: After connecting load cell connector to load cell port, the installation is completed.



Note: Use the knob pole (7) to adjust the inclination angle of indicator and the screw (6) to adjust direction of the indicator. After adjusting the indicator to an optimal position, lock the screw.

5. Setting Mode

5-1 Maximum Weighing Capacity & Accuracy Setting

1. Press and hold key **ZERO/ESC** and **TARE/▶** while powering on the scale. When the window displays “*300. 00 KG*”, release the key and it enter the capacity setting
2. Press **+/PRINT/HI** or **HOLD/LO/-** to choose common used capacity. Press **◀/G/N** or **TARE/▶** to shift the decimal point and press **UNIT** to choose kg, g, lb or 台斤.

Note: if not the needed capacity, long press **UNIT/SET** until the number leftmost is blinking to set the capacity casually. Please do as follows.

- Press **◀/G/N** or **TARE/▶** to shift key leftward or rightward
- Press **+/PRINT/HI** or **-/ HOLD/LO** to change the value.
- Press **◀/G/N** or **TARE/▶** until the decimal point is blinking.
- Press **+/PRINT/HI** or **-/ HOLD/LO** to shift the decimal point
- Press **UNIT/SET** to choose kg, g, lb or 台斤
- Press **ZERO/ESC** to save and enter into division setting when the window displays “*0. 02 KG*”

Note : LONG press **ZERO/ESC** is to return to weighing mode without saving.

3. Press **+/PRINT/HI** or **HOLD/LO/-** to choose common used division. Press **◀/G/N** or **TARE/▶** to shift the decimal point

Note: if not the needed division, long press **UNIT/SET** until the number rightmost is blinking to set the division casually. Please do as follows.

- Press **◀/G/N** or **TARE/▶** to shift key leftward or rightward
- Press **+ /PRINT/HI** or **- /HOLD/LO** to change the value.
- Press **◀/G/N** or **TARE/▶** until the decimal point is blinking.
- Press **+ /PRINT/HI** or **- /HOLD/LO** to shift the decimal point
- Press **ZERO/ESC** to save and enter into calibration setting.

4. The window displays CAL. Press **TARE/▶** to enter calibration setting while LONG press **ZERO/ESC** to exit and return to weighing mode.

5-2 Function Setting

1. Press and hold **UNIT/SET** while powering on or long press **UNIT/SET** under normal weighing mode to enter function setting.
2. Press **◀/G/N** or **TARE/▶** to shift between the functions
3. Press **UNIT/SET** to enter the parameter setting.
4. Press **◀/G/N** or **TARE/▶** to shift between the function parameters
5. Press **ZERO/ESC** to save and return to the previous parameter or long press **ZERO/ESC** to exit without saving and return to the previous parameter.
6. Press **ZERO/ESC** and return to normal weighing mode.

5-3 Description of Parameter Values

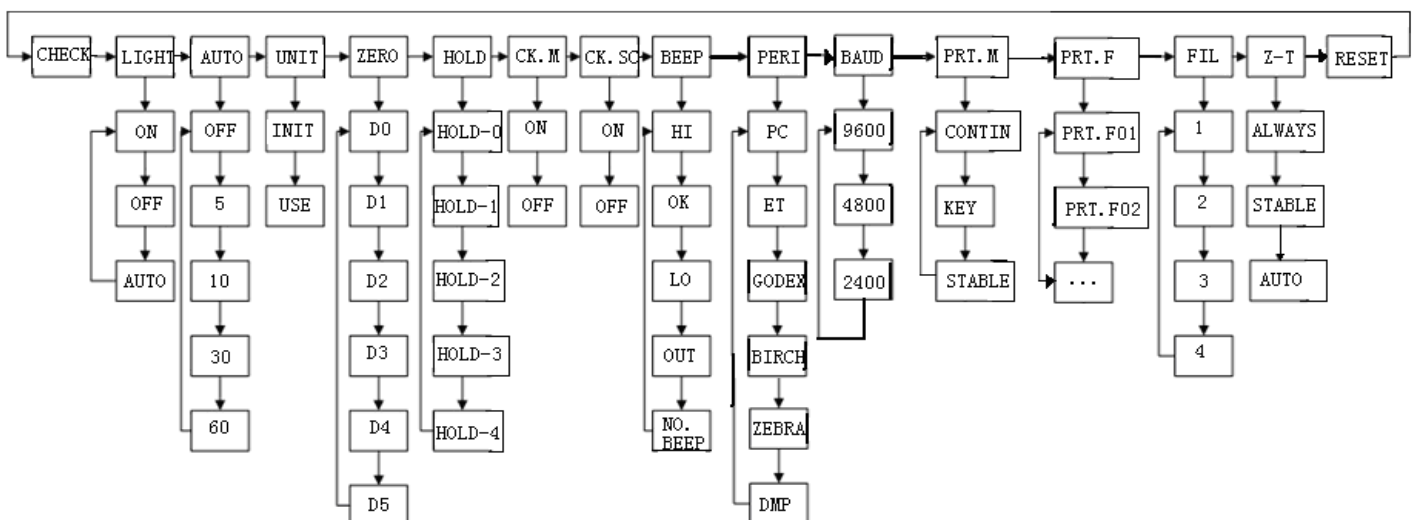

1. **Offset value**

Displays the offset value and the keypad testing can be conducted

2. **Backlight mode**

Off : No backlight

Auto : Auto on with items greater than 9d placed on the weighing pan or any key is pressed.
But auto off after N seconds (N=2s, 4s, 6s... 20s, ever) with no action
ever= It is always on when the weights over 9e

On : Backlight on

3. **Auto-off**

Off : Non power off

5 , 10 , 30 , 60(minutes) : Auto power off after 5, 10, 30, 60 minutes under the condition that there is no action and the weight is equal or lower than 9d

4. **Unit setting**

Init : Press key **UNIT/SET** to select the default unit when powering on the scale: kg, lb...final .(final=keep the final being used unit when power off)

Use: Press key **UNIT/SET** to select the weighing unit. **on** : Enable the unit **off** : Disable the unit

Note: Press **UNIT/SET** to choose the weighing unit. Press **◀/G/N** or **TARE/▶** to enable / disable the unit

5. **Zero range**

d0, d1, d2, d3, d4 and **d5**. (d= scale division)

6. **Hold function**

HoLd – 0 : no hold function

HoLd – 1 : Peak hold. Press any key to release

HoLd – 2 : Hold after stable. Press any key to release

HoLd – 3 : Hold after stable. Release after moving away the article

HoLd – 4 : Press key **HOLD/LO/-** to hold. Press any key to release

NOTE: The function works only the weight is above 20d

7.  **Check weighing memory**

on : Check weighing function is auto-on when restart the indicator

off : Check weighing function would not auto-on when restart the indicator

8.  **Stable Check Weighing**

On: Check weighing after stable indicator appears and the weights is between the upper and lower limit

Off: Check weighing when the weights is between the upper and lower limit

9.  **Check Weighing buzzer beep**

Hi : There will be a warning sound when the weight of articles exceeds the upper limit, and the weight is equal or more than 20d

LO: There will be a warning sound when the weight of articles exceeds the lower limit, and the weight is equal or more than 20d

OK : There will be a warning sound when the weight of articles is between the upper and lower limit (including the upper and lower limits), and the weight is equal or more than 20d

OUT : There will be a warning sound when the weight of articles is beyond the upper & lower limit, and the weight is equal or more than 20d

no.beep : no beep

10.  **External device**, such as ET、PC、JMS、Godex 、BIRCH、ZEBRA、DMP、CX、CK、**T.CONT**、**EXCEL**。

 = Birch printer (paper size 5cm*3cm)

 = Godex printer (paper size 5cm*3cm)

 = Zebra printer (paper size 5cm*3cm)

 = Dot matrix printer

 = Large LED display

 = Computer

EXCEL: Work with the function of “Use Serial Keys” in Windows in outputting the data to Excel. Reference user manual: <http://www.jadever.com.cn/Download.aspx>

CX= CX large screen display (version 0.02)

CK= thermal printer (Chinese available)

JMS=connecting weighing system software

T.CONT= The format of output is compatible with Toledo Continuous Mode

Note: Special setting is needed by distributor if you want to print in Chinese.

11.  RS-232 Serial Transmission Rate

9600 , 4800 , 2400

12.  Print mode

contin : Continuous print

stable : Stable print (weight is equal or more than 20d)

key : Manual print by pressing key **PRINT**

13.  Print format

See the appendix (more than 100 formats. The appendix just shows two formats.)

14.  Filtering setting

Set the filtering level in which the stable indication turns on. The higher the setting, the slower stabilization time

Options: 1 , 2 , 3 , 4

15.  Tare/Zero condition

stable : Only after the stable indication appears, Tare/Zero function acts after pressing down key **TARE** or **ZERO**

always : Tare/Zero function acts by pressing down key **TARE** or **ZERO** even if it is not stable

auto: Press down key **TARE** or **ZERO** even if it is not stable, but Tare/Zero function acts after stable

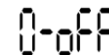
16.  weight memory parameter

OFF: not display the previous weight when powering on again

ON: display the previous weight when powering on again.

17.  parameter initialization

Press **UNIT/SET** twice to begin initialization until the window displays “OK”

6 Calibration

Note: Before calibration, please set the capacity first. The unit used in calibration is the one that has been set before. During the calibration procedure, LONG press **ZERO/ESC** to return to normal weighing mode without saving.

Here we take 3kg/10g as an example

1. Press and hold **TARE/▶** while powering on. Do not release it till the window displays “**CAL**”
2. With no load on the weighing pan, press **TARE/▶** to start zero point calibration.
3. Wait till the window displays the first calibration value. (the window displays **1.000kg**)

Note: The first calibration value is default. If the capacity has been changed, the default value is 1/3 of full load.

If you need to change the value, do as the following: Press **UNIT/SET** to enter the value setting. Press **◀G/N** or **TARE/▶** to move leftwards or rightwards. Press **+ /PRINT/HI** or **HOLD/LO/-** to change the value. Press **ZERO/ESC** to save.

4. Put the corresponding weight on the weighing pan, and then press **TARE/▶** to complete the first point calibration.

Note: After the first point calibration, the window can display the weight value. If no need for the other point calibration, move to Step 6 to finish the calibration procedure.

5. Add another weight to the current weight. The window will show the total weights value. Press **TARE/▶** to complete. Repeat this step to complete multi-point calibration.
6. Press **ZERO/ESC** to save. After the window displays “**0000**”, it will return to normal weighing mode.

7. Operation

7-1 Weighing

Begin with no load on the scale, the display reading zero. Place item(s) to be weighed on the scale. The display shown is 1.000kg, gross weight. (The desired weighing unit should be selected before weighing, refer to section 5-5.)

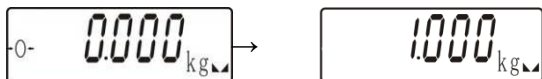

7-2 Manual Tare & Preset Tare

When weighing a sample that must be held in a container, tare stores the container weight into memory.

- 1) Under the weighing mode, place the container on the weighing pan, wait till stable

symbol appears, then press the key **TARE/▶**. The container is tared.



2) Place the item(s) to be weighed into the container. The weight displayed is the net weight.

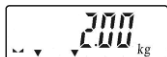

3) Remove all items from the weighing pan, the screen displays the tare value.

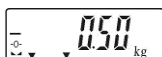

4) To clear tare with an empty pan, press down key **TARE/▶** or key **ZERO/ESC**.

Preset Tare

1) Long press key **TARE/▶** for 3 seconds. The scale is now in Digital inputting mode with the left-most digit blinking.



2) Press key **◀/G/N** or **TARE/▶** to shift leftwards or rightwards. Press key **+ /PRINT/HI** or **HOLD/LO/-** to increase or decrease setting values. E.g. here we set the Preset Tare value as 0.500kg.



3) Press key **ZERO/ESC** to save and return to weighing mode,

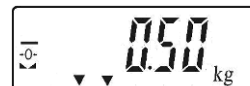

4) Put the load on the container, the scale will automatically deduct the value of the container from the total value.

5) Press **TARE/▶** or key **ZERO/ESC** with no load on the pan if the tare function is to be cancelled.

7-3 Check Weighing

Use this mode to compare the weight of an item to Lower, and Upper limits. When the check weighing mode is enabled, the “▼” indicator will turn on.

Upper limit setting

1) Long press key **+ /PRINT/HI**. The scale is now in Digital inputting mode with the left-most digit blinking.



2) Press **◀/G/N** or **TARE/▶** to shift key leftwards or rightwards. Press **+ /PRINT/HI** or **HOLD/LO/-** to change the value.



3) Press **UNIT/SET** to turn on or off the weighing check

4) Press **ZERO/ESC** to confirm and save the upper limit value.

Lower limit setting

1) Long press key **-/HOLD/LO**. The scale is now in Digital inputting mode with the left-most digit blinking. 

2) Press **◀/G/N** or **TARE/▶** to shift key leftwards or rightwards. Press **+/PRINT/HI** or **HOLD/LO/-** to change the value. 

3) Press **UNIT/SET** to turn on or turn off the weighing check

4) Press **ZERO/ESC** to confirm and save the lower limit value.

Place the sample on the weighing pan.

HI indication appears, when the item on the weighing pan is greater than the upper limit

OK indication appears, when the item on the weighing pan is between upper and lower limits.

LO indication appears, when the item on the weighing pan is smaller than lower limit

Note: the item on the weighing pan should be more than or equal to 20e.

7-4 Simple Counting

1) Press key **UNIT/SET** to select the unit “PCS” under the weighing mode. 

2) Press key **◀/G/N**, the ex-factory default sample quantity (10 pcs) is displayed. 

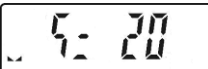
3) Use key **+/PRINT/HI** or **HOLD/LO/-** to choose the sampling amount. Available options are 10、20、50、100、200、500、1000(pieces) . 

4) Put the corresponding samples on the weighing pan, and then press key **TARE / ▶**

“**SAMP**” is displayed momentarily before the display reverts to the sample size.



5) Remove the samples and put the load on, the scale calculates the amount of the load.

6) To go back to the normal weighing mode, remove the load and press key **UNIT/SET** to select the proper weighing unit.

Note:

1. The larger of the sample size, the more accurate unit weight.

2. Symbol “▼” points at “UW” when calculated unit weight is lower than 4/5 of scale division.

7-5 Input commands (Optional)

Connect the indicator and computer. Set Parameter P09 to “**PC**” and P11 to “**Key**”. Run serial port debugging program on the computer. Input the capital number “Z”, “T”, “R” in the sending area, and the indicator can conduct the corresponding actions and have key sound at the same time.

Z=zero T=tare R=print

8. Error message and trouble shootings

Error Message	Problem	Solution
ERR0	Exceed the zero range	The item on the pan should be within 2% of full load.
ERR1	Model setting error. Resolution should be within 300-300000	Adjust or reset the capacity first then adjust resolution
ERR2	Initial zero point exceeds 30% of full load	1.Remove the obstacle article under the pan 2.Replace the load cell or contact the maintenance department.
ERR3	Exceed the A/D resolution range	1. Replace A/D 2..Replace the load cell or contact the maintenance department.
ERR4	EEPROM failure	Re-weld EEPROM or contact the maintenance department.
ERR5	Overload condition	Remove the overload item
ERR6	Exceeds the display range	-----
ERR8	Lower limit is higher than upper limit	Reset the weight limit value.
ERR9	Exceed tare or pre-tare range	$0 < \text{Tare value} \leq \text{full load}$
ERR10	Wrong calibration weights	Place the right test weights and the calibration value should be below full load.

Appendix 1

BIRCH/GODEX/ZEBRA printing format

prt-01

1. 000 kg

prt-02

**G.W. : 1. 000 kg
T.W. : 0. 500 kg
N.W. : 1. 500 kg**

DMP printing format

prt-01

1. 000 kg

prt-02

**G.W. : 1. 000 kg
T.W. : 0. 500 kg
N.W. : 1. 500 kg**

CK printing format

prt-02

**G. W:
1.48 kg
T. W:
0.00 kg
N. W:
1.48 kg**

NOTE:

The printing sample could be of different kinds of formats. When there is specific demand about the format, conduct as follows

- 1) As for **BIRCH/GODEX/ZEBRA** printers, the factory designs the format as planned and email to the user. Add the format into the previous format file via computer. Then it is successful to add the new format and able to print the new format.
- 2) As for **DMP** and **CK** printers, it needs to change the scale design

Appendix 2: Exporting data to PC in the form of EXCEL

Introduction:

Connect the scale with PC and set the parameter of external device as “EXCEL” on the scale, then you could export the weighing data to PC in the form of EXCEL. With this function, you could record/accumulate/average/data statistical analysis the testing data, which we could call it as **scale-computer data management function**.

Note: pls enable “Use Serial Keys” function in the computer.

Hardware connection and settings

1. Use transmitting serial wire or USB wire to connect scale and pc.

Note: pls install usb driver first, if you use usb wire.

2. Parameter settings in scale:

"PERI" = "EXCEL"	(external device)
"BAUD" = "2400"/"4800"/"9600"	(baud rate)
"PRT.M" = "KEY"/"STABLE"	(printing model)
"PRT.F" = "PRT.F01"	(printing format)

Enable the function of “Use Serial Keys” in the computer

Set Windows XP as a example:

1. Press “Start” ->“Run”, and enter “access.cpl” ->”OK”.

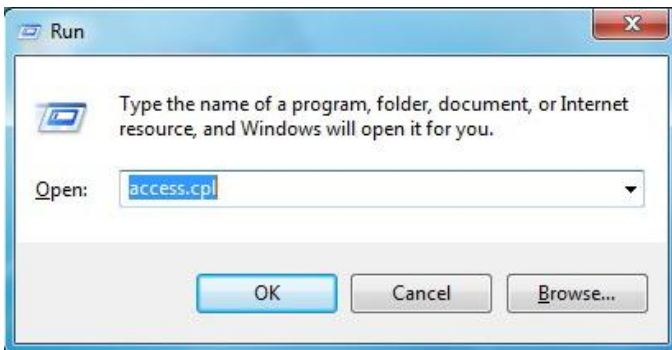

2. In the dialog box “Accessibility Options”, enter General option, choose “Use Serial Keys” and press “Settings”.

In the dialog box “Settings for SerialKeys” , set the corresponding Serial port and Baud rate, which should be same as Baud rate in scale.

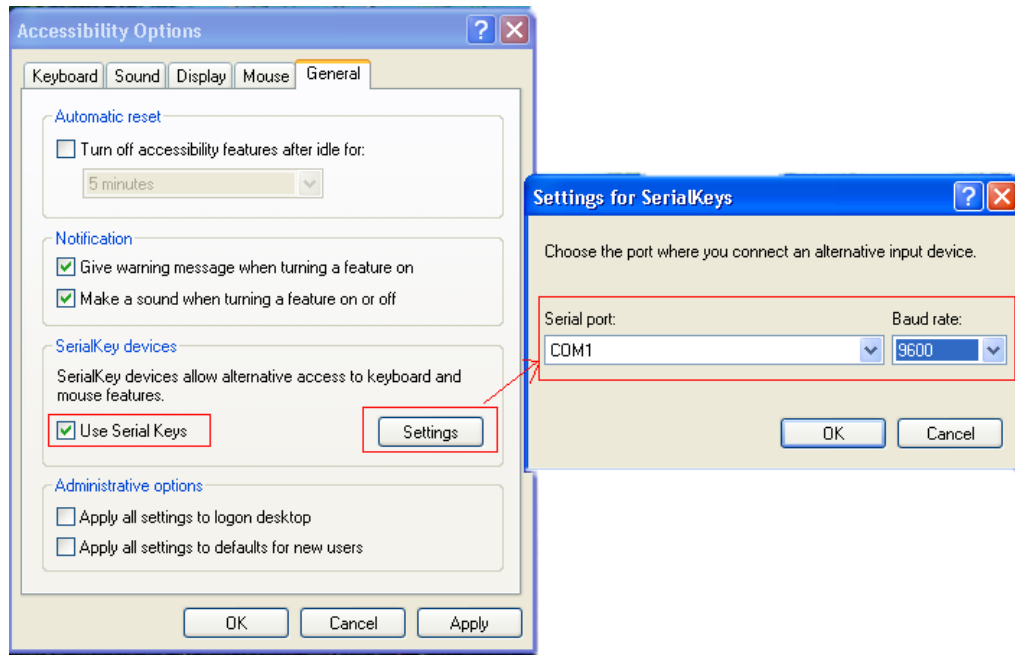

3. Test if Serial Keys works well.

Open a Text Document, and press the Print button on the scale. The Serial Keys works well, if pc exports the weighing data to Text.

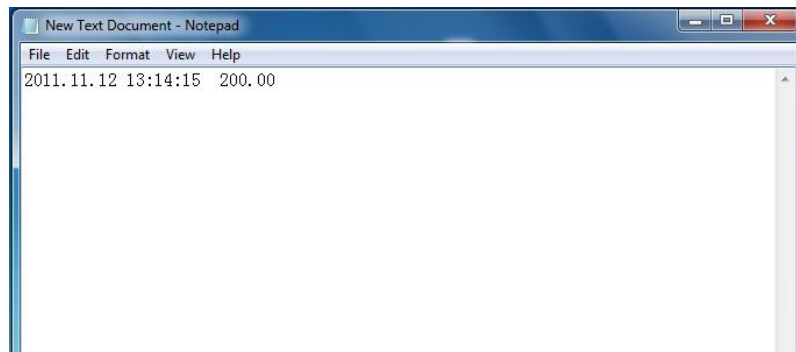

Export weighing data to Excel

1. Open Excel.
2. Press [Print], then Excel will show Date and Weighing data.

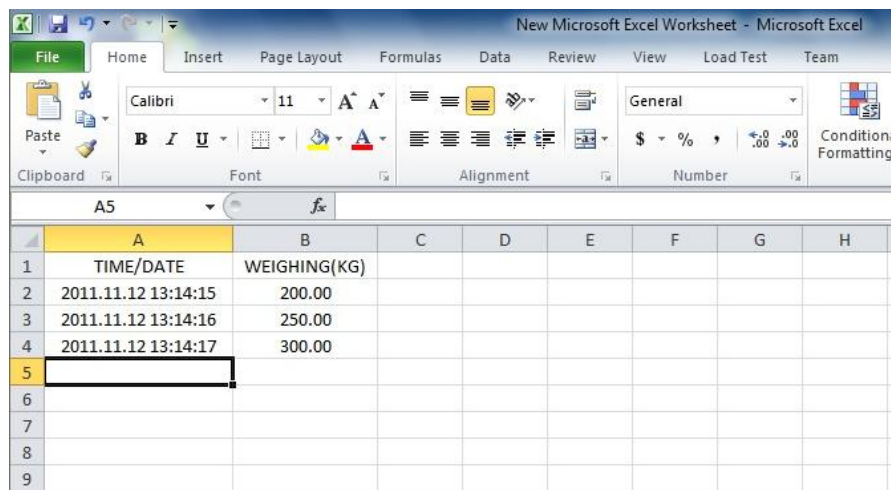

3. Use “Format Cells” to beautify Excel:

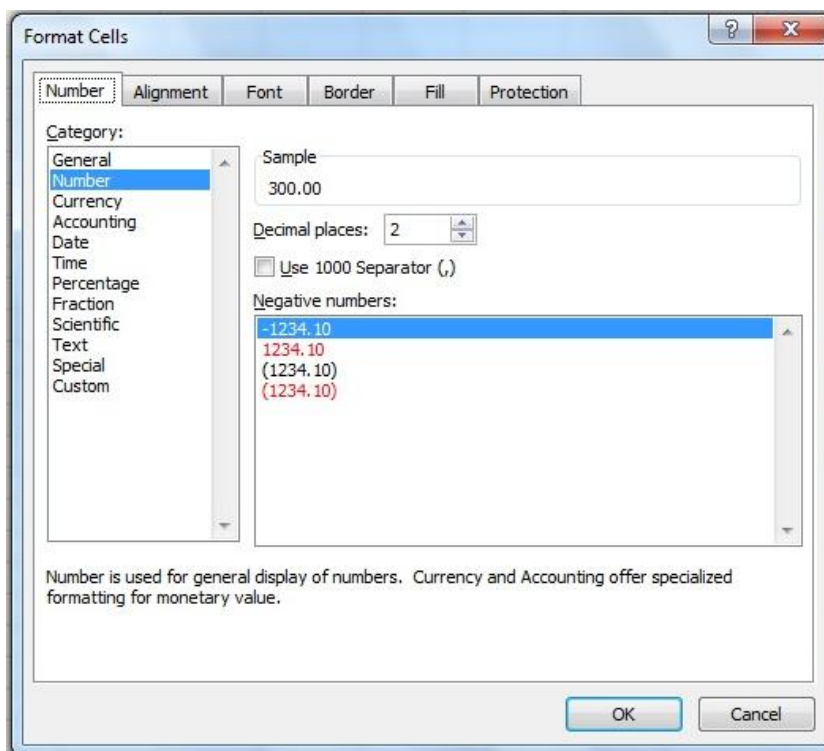

Troubleshooting

1. Enable “Fast User Switching” function will disable “Use Serial Keys” in the computer.
Note: Start->"Control Panel "->"User Account"-> “Fast User Switching” function.
2. The data export requires only “GND+RX+TX” three lines, while some wire include nine lines (including usb 9-25pin adapter), which may cause abnormal function.
Note: cut other useless line to check if these three lines work well.